

Product data sheet

Characteristics

MGL36450

Circuit Breaker, PowerPact M, unit mount, electronic trip, 450A, 3 pole, 18 kA, 600 VAC, lugs both ends



Product availability: Stock - Normally stocked in distribution facility

Price*: 7560.00 USD



Commercial status

This Product is Obsolete :

This Product is Obsolete

Main

| | |
|---------------------------|-----------------|
| Product or component type | Circuit breaker |
|---------------------------|-----------------|

Complementary

| | |
|---------------------------|--|
| Line Rated Current | 450 A |
| Poles description | 3P |
| Breaking capacity code | G |
| Magnetic tripping current | 900...4500 A |
| Electrical connection | Lugs load Lugs line |
| Terminal identifier | AL800M23K |
| Tightening torque | 442.54 Lbf.In (50 N.m) 0.15...0.37 in ² (95...240 mm ²) (AWG 3/0...500 kcmil) |
| Height | 12.86 In (326.6 mm) |
| Width | 0.32 In (8.06 mm) |
| Depth | 8.27 In (210 mm) |
| Continuous current rating | 80 % |

Ordering and shipping details

| | |
|-----------------------|-----------------------------------|
| Category | 01205 - MG, MJ UNIT MOUNT BREAKER |
| Discount Schedule | DE2 |
| GTIN | 00785901507666 |
| Nbr. of units in pkg. | 1 |
| Package weight(Lbs) | 29.02 Lb(US) (13.163 kg) |
| Returnability | Yes |
| Country of origin | US |

Packing Units

| | |
|------------------------|----------------------|
| Unit Type of Package 1 | PCE |
| Package 1 Height | 10.80 In (27.432 cm) |
| Package 1 width | 12.00 In (30.48 cm) |
| Package 1 Length | 18.00 In (45.72 cm) |

Offer Sustainability

| | |
|----------------------------|--|
| Sustainable offer status | Green Premium product |
| California proposition 65 | WARNING: This product can expose you to chemicals including: DIN-P, which is known to the State of California to cause cancer, and DID-P, which is known to the State of California to cause birth defects or other reproductive harm. For more information go to www.P65Warnings.ca.gov |
| REACH Regulation | REACH Declaration |
| EU RoHS Directive | Compliant EU RoHS Declaration |
| Mercury free | Yes |
| RoHS exemption information | Yes |
| China RoHS Regulation | China RoHS Declaration |
| Environmental Disclosure | Product Environmental Profile |
| Circularity Profile | End Of Life Information |
| PVC free | Yes |

Contractual warranty

| | |
|----------|-----------|
| Warranty | 18 months |
|----------|-----------|

Approximate Dimensions

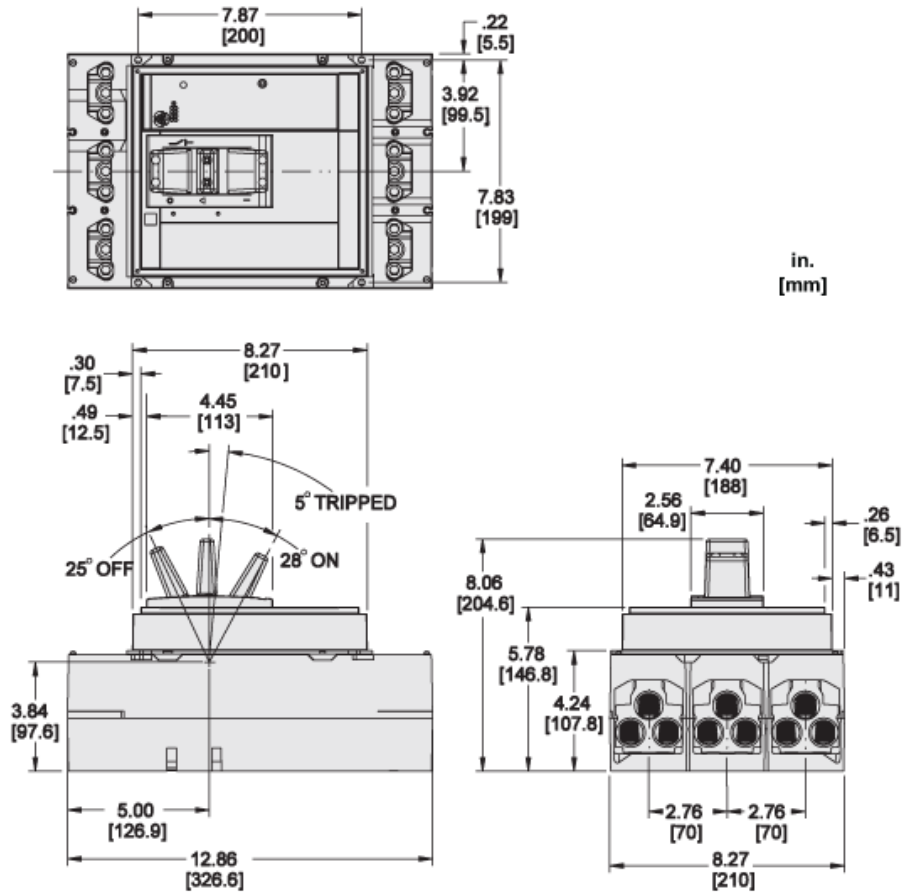

Product Life Status : **End of commercialisation**

MGL36450 may be replaced by any of the following products:



MGL36800E10

Circuit breaker, PowerPact M, adj trip, unit mount, 300A-800A, 3 pole, 18 kA, 600 V, lugs

Qty 1

Substitution date: |